

A Review Paper on Early-Stage Corrosion Detection in Reinforced Concrete Structure with Piezo-Electric Sensor

Aishwarya Thakur¹ and Saurav²

¹Post Graduate Research Scholar, Civil Engineering Department, Jaypee University of Information Technology, Solan, H.P.

²Assistant Professor, Civil Engineering Department, Jaypee University of Information Technology, Solan, H.P.

Article Info

Volume 82

Page Number: 9973 - 9985

Publication Issue:

January-February 2020

Abstract:

Recent advancement in science and technology opened multiple doors to researchers and academicians now days. Use of technology is not limited to one domain rather interdisciplinary themes are gaining pace. In this paper review of similar interdisciplinary works carried by different researchers across the globe is discussed confined to non-destructive method of corrosion detection in reinforced concrete (RC) structures. Right now time corrosion checking in RC structure utilizing artificial and piezo-electric sensors is altogether talked about. One can't deny the way that the corrosion assumes a significant role in basic wellbeing observing structural health monitoring (SHM). Corrosion affects the mechanical strength of hardened concrete with passage of time. Concrete exposed to chloride and sulphate is severely affected by the haunting phenomenon of corrosion. In order to provide an efficient SHM technique to the exciting structures use of electronic sensors plays a critical role. The location procedure relies upon the manner in which that the frequency of consumption adjusts the auxiliary firmness, the mass and the damping, accordingly consecutively altering the reaction of the framework, which is spoken to as a size change in segment inside the electrical phenomenon and susceptance marks. Right now, referenced propelled procedures of corrosion identification to be educated regarding most recent advancement in the field of consumption checking and auxiliary wellbeing perception. In RC structures reinforcements are usually provided in form of steel bars which can withstand tensile loads or stresses. These steel bars are vulnerable to corrode once they are in touch with corrosive environment with passage of time. Initiation of corrosion not only leads to mass loss in steel bars but also deteriorate the overall structures. Many experiments were conducted to carry out and quantify the amount of corrosion affecting a structure but these tests were destructive types. With recent advancement in technology non-destructive testings were analysed and performed on reinforced steel bars using different artificial electric sensors like piezo-electric sensors, optical fibre sensors, acoustic sensors etc. These non-destructive methods of testing are more accurate and less time consuming giving a real time monitoring of the existing structures. In this paper different non-destructive methods of testing available for corrosion monitoring are discussed with their merits and demerits. Works carried by different researchers on SHM and non-destructive method of detecting corrosion using electronic artificial sensors are discussed.

Article History

Article Received: 18 May 2019

Revised: 14 July 2019

Accepted: 22 December 2019

Publication: 17 February 2020

Keywords: Corrosion identification, damage detection, mechanical impedance, structural monitoring.

1. Introduction

Concrete is the most usually used building material and holds a primary importance in building material categories. Concrete gain its strength from hydration products primarily through C-S-H gel. Property of concrete which made it popular is its ability to withstand compressive stresses. Concrete is tough in compression but sick in tension. Reinforced cement concrete (RCC) is that concrete which can take both stresses viz compression and tensile. RCC structure can be exposed to different types of environment which affects the serviceability of the RCC causing damages leading to initial losses and commercial losses[1]. One of the major deterioration of RCC is when the embedded steel gets corroded. This reduces the axial and bending quality of components, makes them basically powerless. Although corrosion of embedded steel bars may not be visualised from outside of the structure and structure may look stable but actually, the corroded structures become vulnerable for design loads (extreme burdens), for example, a solid ground movement can build the stress activities beyond the limit of the sections. Loss of strength can occur in steel and reinforced solid structures.

Corrosion is often defined because the chemical or electrochemical response between materials, for the most parts a metal, and its environment, which causes weakening of the material and its properties. Steel corrosion starts when dampness enters the defensive boundary of the surface, causing rust, which has two to four times the original steel volume [2-3]. In addition to structural design errors, the main reason of downfall and early failure of reinforced solid structures is the corrosion of steel reinforcement. Although the loss of mass in the structure as a result of corrosion is low in most scenarios and mechanical strength is considerably lower and the fatigue occurs more quickly. Thus, improving the effective technology of corrosion detection using electronic sensors can significantly reduce costs and give more secure structures [4]. Different strategies using sensors for identifying

corrosion have been given in recent years by many researchers. As we all know corrosion is an electrochemical process, the standard ways of estimating consumption are chemical techniques, half-cell potential techniques, right polar opposition techniques, and qualitative analysis of electrochemical impedance, electrochemical cries and the investigation of consonants [5]. The results of these methods may indicate a risk of corrosion, which is subjective. One of the major drawbacks of this method is judgmental monitoring of localized corrosion. A new era has recently opened up for estimating methods of consumption or perceptual corrosion in the field of intelligent materials and the elementary verification of success, to allow some examples, electromechanical impedance and fiber detection work optical observation of acoustic radiation. Regardless of the manner in which that these new systems have shown promising, they are still to start with up stage and need more assessments [6].

This paper clarifies an altogether new strategy for evaluating consumption discovery in steel rebars utilizing an electromechanical impedance (EMI) method with a piezoelectric transducer (PZT) [7]. This EMI procedure is a non-dangerous strategy that creates in Structural Health Monitoring since it is considered by recurrence of high range and quick reaction. In ongoing time, impedance method has demonstrated its functionality for genuine basic wellbeing observing for a decent style of specialized structures. Adding to this, significant semi-examinations of structures normally require END techniques with huge and genuine instruments, along these lines expanding the issue of perception structures, for example, long range suspension spans. A well-organized SHM model will decrease structural expenses by distinguishing damage to the degree associated with an initial age, creating movement to avoid additional damage. One potential philosophy is that of the EMI methodology since it utilizes a singular PZT transducer for every instrument and indicator [8]. The good thing about the strategy is that it will determine the internal

damage to a generally negligible effort. Moreover, since it uses high-repeat excitation, the different vibrations of the state of the surface similarly as the vehicles and the breeze will have no broad effect on the EMI framework. However, most analyzes exist under a controlled scenario or in a research laboratory. For example, the repetitive demonstration and strength of EMI invention are continually studied [9]. Amazing studies of the EMI techniques have been found in earlier studies. That is why our study of the EMI technique in this review is largely focused on researches that have been conducted over the past years, by the aim that the industrialist see that the strategy has enhanced so far. The chronicle gives a transient explanation of the EMI methodology, trailed by pictures of unequivocal separates finished on steel bar tests.

2. Electromechanical Impedance (EMI) Technique

The word "piezo" comes from a Greek word that implies pressure. The evolution of the piezoelectric effect is found in by Paul-Jacques Curie and Pierre in 1880. This occurs in exchangeable non-centroid precious stones, for example, zirconate-lead titanate [PZT, $Pb(Zr_{1-x}Ti_x)O_3$], Lithium Niobate ($LiNbO_3$) and quartz (SiO_2), in which electric dipoles (surface charges) are created when the crystal becomes exposed to mechanical pressure [7]. PZT transducers fit in to the class of sensitive materials since they exhibit an incentive feedback conduct, i.e. they work directly, they produce electrical charges under mechanical load; and conversely, the quadratic measurement of mechanical distortions is performed as soon as an electric field is functional below miniature field settings as appeared in Figure 1. The quadratic measurement of immediate and reverse effects is described by Ikeda [10-11].

$$D_3 = \overline{\epsilon}_{33}^T E_3 + d_{31} T_1 \quad (1)$$

$$S_1 = \frac{T_1}{Y^E} + D_{31} E_3 \quad (2)$$

Here,

S_1 - strain on axis '1', as shown in Figure 2,

D_3 - Electrical uprooting over the outside of PZT fix

d_{31} - Piezoelectric strain constant,

T_1 - Axis stress inside the fix on the hub '1' as shown in Figure 2,

$$\overline{Y^E} = Y^E (1 + \eta_j)$$

-Complex Young physical ownership module in the constant electric field and

$$\overline{\epsilon}_{33}^T = \epsilon_{33}^T (1 - \delta_j)$$

-Complex electrical nonrestrictive at stable stress,

η and δ - Mechanical and dielectric failure elements of the fix. From Figure 2 it can be observe that axis '3' points on the thickness of the fix whereas axis '1' and axis '2' lies within the plane of the fix. The EMI method is a relatively new method for monitoring structural health. The SHM method is discovered by Liang et al and so developed by many analysis teams such as Guirgiutiu and his colleagues, Park et al, Bhalla et al. The EMI technique has been the subject of an experiment that has proven to be terribly powerful in detecting early damage localized in an extremely structural type [12-13]. In this monitoring method, a PZT patch is fused to the observed material on the surface as shown in Figure 3(a), 3(b), associated with an electrically excited electric degree of an impedance analyzer [14]. Advanced expression for electromechanical process is presented with \overline{Y} .

$$\overline{Y} = \frac{\overline{I}}{\overline{V}}$$

$$\overline{Y} = G + Bj4\omega j \frac{l^2}{h} \times \left\{ \overline{\epsilon}_{33}^T \frac{2d_{31}^2 \overline{Y^E}}{(1-\theta)} \frac{2d_{31}^2 \overline{Y^E}}{(1-\theta)} \left[\frac{Z_{a,eff}}{Z_{s,eff} + Z_{a,eff}} \right] \left[\frac{\tan kl}{kl} \right] \right\} \quad (3)$$

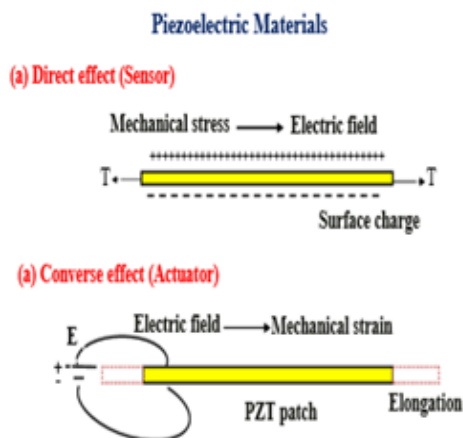

Figure 1. Immediate And Reverse Effect Of Piezoelectric Material

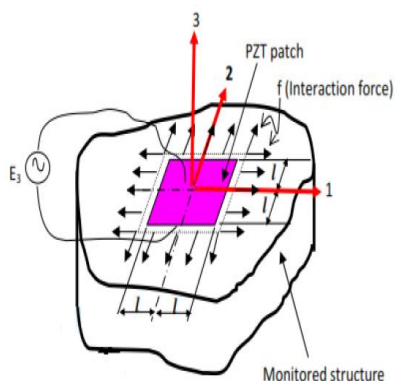

Figure 2. Interaction Of Structure By The Use Of Effective Impedance - Modelling Of PZT

Here,

h -Thickness of the patch,

ν -Poisson's quantitative relation,

d_{31} -Piezoelectric strain constant of the PZT substance,

\bar{Y}^E -Complex Young modulus beneath consistent force field,

$\bar{\epsilon}_{33}^T$ -Advanced electrical consistency at steady pressure,

$Z_{s,eff}$ -Short-circuited effective mechanical impedance of PZT fix,

ω -Angular frequency ν is rakish repetition,

k -Frequency,

G -Conduction and

B -Susceptance [15].

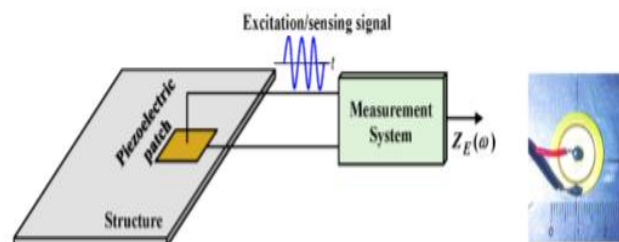

Figure 3. (a) Principle Of The EMI Technique (b) Piezoelectric Transducer

3. What Is Structural Health Monitoring (SHM)

Structural health monitoring (SHM) is a technique in which series of connected sensors used to collect and analyze information at any time during the life span of the structure. The purpose of such a system is to detect and quantify any damage or deterioration that may occur during the lifetime and Figure 4 gives the chronological steps implicated in SHM of any structure [16]. Whereas SHM systems may differ in design and preparation, and they all contain four different subsets:

- Periodic measurements by a series of sensors;
- Structural identification;
- Processing information to detect damage;
- Analysis of results and decisions.

3.1. Needs of SHM

The technique for conducting a study of reinforced concrete structures that are influenced by reinforcement corrosion is currently well documented and various techniques will be used to make such an assessment. Different electrochemical techniques were used for assessing the corrosion of cement mixtures in contaminated chloride mixed with fly ash concrete. All these techniques will be used individually or in combination provide an integrated approach to the state of a structure. Because Concrete engineers are interested in the rate of degradation of structures, it is useful to monitor

dynamic conditions over time. This is currently being implemented on new structures with long-term requirements and older structures in case of corrosion damage found and the repair is delayed due to value, delivery or other reasons [17]. Currently, the accessible probes don't meet all the needs range of the most recent innovations, reasonable observation probes for existing structures are accordingly created, covering the most significant principle instruments of deterioration. Corrosion of reinforcement, carbonization of concrete, freeze-thaw damage, reaction to alkaline aggregates and mechanical damage (overload) [18]. The advancement of these systems will be anticipated by examination equipment parameters (temperature, humidity, pH, chloride concentration, current / corrosion rate /beginning) either on the surface or in profile through the concrete of the structure as mechanical parameters (tension, deflection, vibrations, acoustics). The end result is an integrated system for observing existing structures, including:

- Prototypes of integrated observation systems.
- Manual for on-site personalization of monitoring systems.
- The prototype of an integrated model of damage development.
- Prototypes of the latest innovative and inexpensive probes, and
- Native data collection units combined with a long-distance data transfer system. It is considering that the use of this technique could lead to reductions of around 15% current operational prices.

Table 1. Merits & Demerits of Corrosion Detection Methods [20].

Monitoring Methods	Merits	Demerits
Half – cell potential measurement [21]	<ul style="list-style-type: none"> • Common regular inspection procedure of reinforced concrete structures (RC) • Simple and profitable 	<ul style="list-style-type: none"> • It only gives data on the risk of corrosion, cannot indicate a pace of corrosion. • Sometime the values generated are not desirable.

Some of the monitoring strategies in the field are:

- Permanent observation of the state of the concrete and reinforcement by corrosion probes and reference electrodes.
- Analysis of the potential durability of concrete structures and appropriate preparation maintenance and repair strategies.
- CP design for reinforcing concrete structures and quality assurance of installations.

Many different sectors of the industry, as well as the bridge authorities, nuclear power, offshore, houses, construction, port structures use corrosion sensors for monitoring [19].

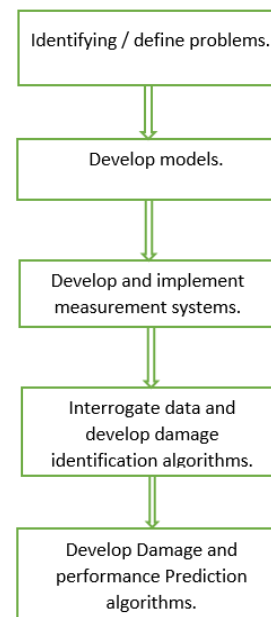

Figure 4. Steps Involved In SHM

4. Previous researches on corrosion monitoring using PZT fixes.

<p>Corrosion Coupons [22]</p>	<ul style="list-style-type: none"> • Cheap yet more effective method for corrosion monitoring • Different type of corrosion can be detected by using these coupons like Pitting and Galvanic corrosion. 	<ul style="list-style-type: none"> • Corrosion coupon testing limits are only average corrosion measurements during exposure, corrosion rate calculated only after removal of coupon from pipeline, short exposure period may result non-representative corrosion rates and the surfaces of the coupons are smooth and polished.
<p>EMI technique [20]</p>	<ul style="list-style-type: none"> • It is extremely compelling strategy for recognizing restricted harm in an assortment of structures. • EMI ability is good for long time monitoring. 	<ul style="list-style-type: none"> • Keeping up sensor health and bonding is significant. • It involves information of a healthy social organization.

S. Park et al. has confirmed the EMI system utilizing a functioning sensing device comprising of a scaled-down impedance estimation chip and a self-recognizable full-scale fiber composite mortar to identify and measure corrosion in aluminium structures [23]. Jr. Stews reported the use of the EMI framework to recognize harm realized by consumption in plates and shafts and construed that the impedance strategy fits best with the Changes in the significance of the corrosion pit perceive and assess surface erosion before splitting, which decreases the administration life of the structures [24]. Thomas et al. used lamb wolves to perceive the loss of material on account of consumption in the dainty plate, specialist of carrier skins utilizing piezoelectric position sensors in a pitch fix structures and start that while the sheep's wave experiences the

re-sanctioned corrosion harm, the sign has changed and connected with the degree of the harm [25].

Lalande et al. utilized the impedance strategy to examine complex accuracy parts, for example, those found in speed sets. Gears are often utilized parts with high resilience, so that is accepted the impedance technique can distinguish damage to the rigging tooth through the essential structure. Tooth Bending weakness and rough tooth wear are the most widely recognized kinds of damage in the unpredictable machines and it was conceivable to identify the two sorts of damage utilizing the impedance strategy. Grating wear is similar to disintegration (a kind of erosion), which exhibits the convenience of the impedance technique [26]. Bhalla et al. (2005) provided an in-depth review of accessible detection technologies and global

observation strategies, with specialized selection in near ground conditions [27].

5. Impedance Based Structural Health Monitoring (ISHM)

The essential course of action behind this plan is to watch the mechanical impedance changes of the structure achieved by the nearness of harm. Since straight observing of the mechanical impedance of the structure can be an extreme undertaking, the strategy utilizes piezoelectric materials bonded or consolidated into the structure, permitting estimation electrical impedance [28]. It is said to be against the mechanical quality of the structure, which is influenced by the event of harm. It is clear that it was felt that the actuator of the electric sensor utilized in the perception the system stays intact with the test.

6. Impedance Analyzer

The ISHM system utilizes two variants at the same time, immediate and converse, of the piezoelectric impact. Utilizing a high repetition of excitation (to the ordinary degree of the explicit evaluation test), the dynamic reaction of the structure tends only to the near space of the sensor and is not affected by the conditions of the farthest point [29]. At that time, the mechanical vibration response is transmitted to the sensor within the type of electrical response. Precisely when lacking mischief recognizes changes in the dynamic reaction (given by the impedance signal), this can be found inside the electrical reaction of the PZT fix. The electromechanical model that evaluates and portrays the estimating technique as shown in Figure 5 for a solitary level of-opportunity framework (1 DOF). Impedance estimation utilized for health-monitoring of systems contains impedance values for an extent of frequencies. These estimations are routinely performed using an impedance analyzer. The electrical impedance of the related PZT is proportionate to the voltage of the PZT isolated by the voltage travel through the PZT. An impedance

approach is made by taking the report with the FFT analyzer from the voltage suited the circuit, V_o , on an unquestionable affirmation resistor, V_i , to the voltage, R_s , in procedure with the PZT as appeared in Figure 6. This circuit can be seen as a voltage divider.

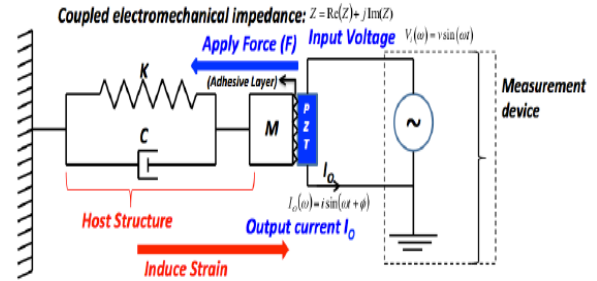

Figure 5. Mechatronic 1 DOF Representation of the Impedance- Based Structural Health Monitoring Method

The yield voltage is similar with the current by the ID resistor that, if the territory obstacle is low (under 200), is commonly the current through the PZT if the affirmation limitation was dismissed (as while evaluating with typical impedance analyzer). The circuit is depicted as seeks after assessment:

Where 'I' is the resistance of detection. The estimated impedance (Z) is:

$$Z = \frac{V_i}{I} = \frac{V_i}{V_i / R_s}$$

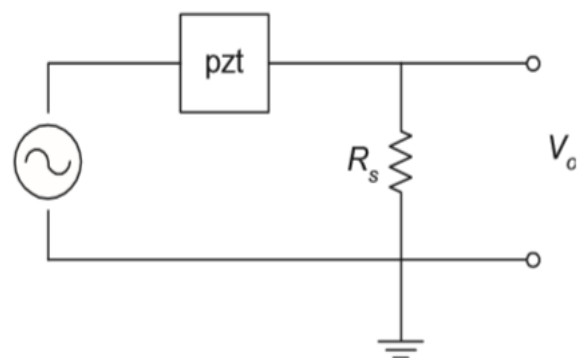

Figure 6. Circuit for Resembling PZT Impedance.

Since the PZT is a capacitive part and current going through this part will increment with repetition. Despite what might be expected side, low frequencies, the circuit has high impedance. For this situation an upsetting speaker circuit is utilized to give a more prominent yield voltage. The components of the discovery of opposition can be expanded, yet this decreases the voltage on the PZT (a bigger fall happens on the detection resistance).

7. Adhesive Width

Sirohi and Chopra (2000), Crawley and de Luis (1987), showed in series the performance and detection of ordinary beam elements by means of a PZT transducer fixed with adhesive. The researchers (Xu and Liu, 2002) proposed that the PZT transducer must be attached to the structure utilizing a high modulus of adhesive with the least possible thickness. A shear modulus of elasticity of the cut that is too low or too often can give incorrect or misleading answers, such as overestimating the maximum frequencies or dominating the PZT frequencies themselves. In addition, in the request to limit the emission of the junction layer, minute PZT transducers must be chosen for structural recognition [30].

8. Accelerated Corrosion Test on Probe

To imitate the material disappointment or mass disappointment due to corrosion, the probe is a kind of prediction of the accelerator corrosion test. The initial weight of the metal rod is measured, before the corrosion test. The arrangement for the accelerated corrosion test is appeared in Figure 7. The probe is subjected to corrosion test. In this test, the probe is poured into a separate precipitation vessel with a 3.5% NaCl solution. The anode is associated with the probe, and therefore the cathode is associated with a copper plate, within the accelerated corrosion tests. Both the probe and along these lines the copper plate is submerged inside the NaCl arrangement [11]. The DC power supply is

utilized to impress current. The Corrosion within the probe is begun upon the appliance of electrical flow.

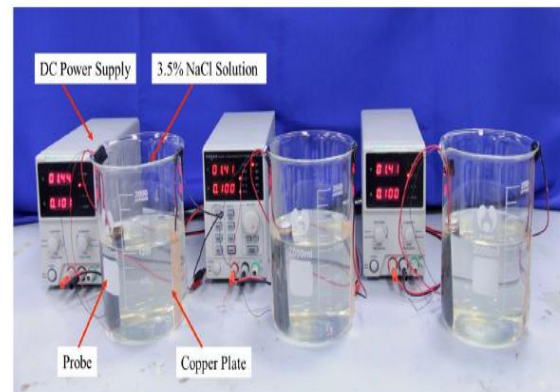

Figure 7. Accelerated Corrosion Process

9. Purposed Experimental Study

In the EMI framework, a PZT actuator/sensor fix will be clung to the outside of the structure (whose wellbeing is to be watched) using great epoxy stick as appeared up in Figure 8. The admittance imprint or mark of the fix will get over a high-repeat run (30-400 kHz). This imprint shapes the benchmark for assessing the fundamental wellbeing. At any time of future driving, when it should outline the idea of the structure, the engraving will be segregated again and isolated and the benchmark signature [2].

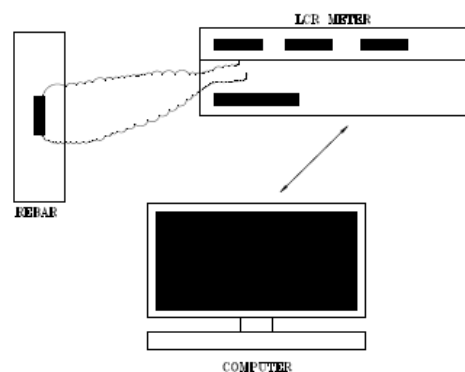

Figure 8. Purposed Experimental Setup

The mark of the reinforced PZT fix will typically obtain by methods for financially accessible LCR meters such as Agilent E4980 LCR meter. The LCR meter will force a trading voltage indication of 1

volts RMS to the faces PZT transducer above the client demonstrated predetermined recurrence run (for instance 100-300 kHz). The magnitude and the period of the enduring state current will straightforwardly record as conductance furthermore, susceptance marks in the frequency domain, along these lines taking out the requirements of the domain changes, without intensifying. The conductivity signature or marks got from the monitor attached will demonstrate the adjusted mechanical impedance because of corrosion. Corrosion can change the properties of the structure, leading to a clear reading before & after corrosion of the conductivity signature. This changed type of the conductivity mark can transform us to rapidly find corrosion utilizing the EMI procedure.

10. Damage Assessment

In impedance technique, damage recognition is typically obtained by watching the adjustments in the electrical impedance marks when contrasted with pattern estimation. The outcomes are qualitative. Right now, scalar measurements should be described to assess the differentiation in the impedance checks between the broken conditions and therefore in good physical form. For assessing the assortments in the impedance marks for dissimilar harmed conditions, the ordinarily utilized verifiable estimations, RMSD, MAPD, Cov and CCD, were gotten. These measurements were seen as dependable signatures for evaluating structural damage [7].

RMSD metric is outlined as

$$RMSD = \sqrt{\frac{\sum_1^N (G_i - G_i^0)^2}{\sum_1^N (G_i^0)^2}} \times 100 \quad (4)$$

Wherever,

G_1 - Conduction of the PZT,

G_0^1 - starting point (in the virgin state),

T symbolize the frequency index (50-400 kHz).

The result zone unit with the estimation of RMSD for what it's worth. Receptive to helper changes and moreover the estimation will increment with increment in its losses. The features of an organized

alteration at that point change (e.g., because of harm, temperature changes, and so on). The impedance signatures, since extra and additional varieties are dependent upon more prominent damage. Because of this, when the signature for electrical resistance is acquired, it is important to decide the significance of the desecration [9]. Mainly, there are 4 factual examinations are utilized for the numerical estimation of signatures.

$$RMSD = \left(\sum_{k=1}^N \frac{[R_e(Z_k)_j - R_e(Z_k)_i]^2}{N \sum_{k=1}^N [R_e(Z_k)_i]^2} \right)^{1/2} \quad (5)$$

$$MAPD = \frac{1}{N} \sum_{k=1}^N \left| \frac{1[R_e(Z_k)_j - R_e(Z_k)_i]}{N R_e(Z_k)_i} \right| \quad (6)$$

$$Cov = \frac{1}{N} \sum_{k=1}^N [R_e(Z_k)_j - R_e(\bar{Z})_j] \times [R_e(Z_k)_i - R_e(\bar{Z})_i] \quad (7)$$

$$CC = \frac{1}{N \sigma_{Z_j} \sigma_{Z_i}} \sum_{k=1}^N [R_e(Z_k)_j - R_e(\bar{Z})_j] \times [R_e(Z_k)_i - R_e(\bar{Z})_i] \quad (8)$$

Here,

(RMSD) -Root Mean Square Deviation,

(MAPD) -Mean Absolute Percentage Deviation,

(Cov) -Covariance,

(CC) - Correlation Coefficient,

$R_e(Z_k)_i$ - Reference Impedance signature (real part),

$R_e(Z_k)_j$ - Matching signature (real part),

N -Number of Impedance signatures,

σ_Z -Standard Deviation and

Z - Mean values [9].

The corrosion variety of steel in concrete can be discovered through the obstruction versus frequency spectra of the PZT transducer. Quantitative damage indices are employed to assess the corrosion procedure. The root means square deviation (RMSD), mean absolute percentage deviation (MAPD), correlation coefficient (CC) is the main corrosion indices. The resistance versus frequency spectra shows the mechanical impedance variation of corroded steel [2]. Corrosion indices of PZT transducer in different frequency intervals show the relation between CC index Figure 9(a) RMSD index Figure 9(b), MAPD index Figure 9(c) with a relative mass loss percentage [1].

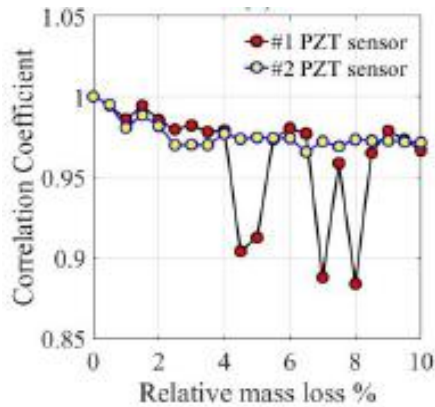

Figure 9(a). Correlation Coefficient

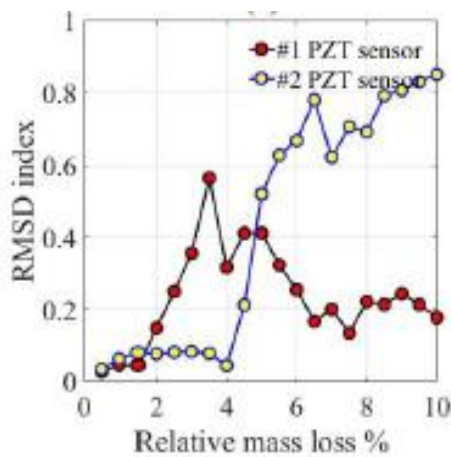

Figure 9(b). RMSD Coefficient

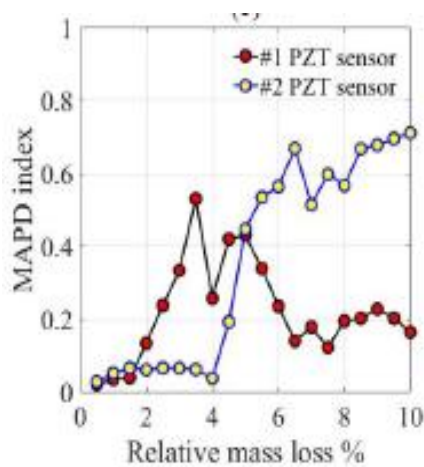

Figure 9(c). MAPD Index

11. Future Work

Bond Toughness, PZT Deterioration, Detection Range and Reference mark

With respect to EMI innovation, apply to the SHM framework, the quality of the PZT transducer and consequently the excellent holding capacity. These are numerous PZT makers that have a PZT disintegration capacity of fewer than 5% for enhancement, and are in this manner made of characteristic material. Natural components like changes in temperature over an all-inclusive time of at some point can add to warm weakness, while deluge or ocean water presentation could cause acidic and basic assaults. In the summary, the PZT transducer is supported by the central part of mechanics and electronics. Despite the course that there are ways to deal with oversee watch the PZT transducers, for instance, installing them into the structure or covering them with silicon or epoxy, the PZTs can't be removed on the off chance that they're hurt. In general, varieties within the properties of the cover (silicon or epoxy) are often changed by the signatures of the impedance, causing a fault alarm. As a result of the cause, the influence of the elementary elements must be eliminated through the compensation algorithm, or through the utilization of a control or numerous PZT transducers. As to recognizing range, the EMI strategy may be a local method that utilizes high repeat excitation. Subsequently, the distinguishing range is restricted to a couple of measures, dependent upon the characteristics of the PZT and thusly the host structure. Considering, cost issues create when managing colossal advancements, as countless PZT transducers should be created. This indicates that only the EMI is in use for the transmission of the SHM system is very difficult, but it is incorporated in a global way (for example, accelerated and timeline) to create a SHM method. A mix of the EMI framework with the guided wave-based system has been researched in Giurgiutiu et al. where it was set up that the EMI structure was viewed as fitting for hurt area in the nearby by field while the guided

wave based technique was intensely consistently sensible for far-field hurt ID (Na et al, 2018). Considering, one of the first undertakings for carrying on the EMI system is to get a reference signature in a 'no harm' state. Set up reference, mark is then showed up contrastingly corresponding to a hurt state at a later point to see any harm to the structure. Fundamentally it is inside and out that truly matters hard to grow a 'no damage' state impedance signature for existing structures, future assessments could be established on using the EMI structure without the use of a reference signature, either by applying the framework alone or in reinforcing with other NDT procedures.

12. Conclusions

The most important reason for our exploration is constrained to the utilization artificial sensors for determining corrosion in RC concrete structures. In this review paper focus was confined to evaluation of corrosion using modern non-destructive methods as suggested by researchers. This paper reviewed the applications of EMI strategy and its evaluation technique, along with an accentuation on the latest examination in this field. In this paper merits and demerits of different methods available till date are discussed. Method of detecting corrosion using piezo-electric is based on impedance technique and can be suitable for SHM. These methods quantify corrosion realistically. It has been observed that EMI technique is very useful and effective in detecting corrosion at an early stage. Hence EMI system can be utilized to assess structure progressively all together that corrosion could be distinguished and treated before basic splitting makes.

Various experimental works done for detecting corrosion using EMI technique reveals that with increment in corrosion magnitude of conductance decreases. Through graphs it can be observed that conductance of corroded sample becomes flattened and smooth. Damage quantification was also one of the major parameters which can be detected in EMI technique using RMSD, MAPD and CCD. These metrics shows and elevated results with increase in

corrosion amount. RMSD record end up being successful quantifying damage by differentiating distance and size from the sensors. Piezo-electric sensors may be used for corrosion detection as it can correctly correlated damage and size classification for large structures.

REFERENCES

1. W. Shi, Y. Chen, P. Liu and D. Xu, "Corrosion Investigation of Reinforced Concrete Based on Piezoelectric Smart Materials". *Materials*, vol. 12, no. 3, pp.1-10, Jan. 2019.
2. T. Visalakshi, S. Bhalla and B. Bhattacharjee, "Detection and quantification of corrosion using electro-mechanical impedance (EMI) technique". *International Journal of Earth Sciences and Engineering*, vol. 4, no. 6, pp.889-891, Oct. 2011.
3. Bhalla, S. and KiongSoh, C., "Structural impedance-based damage diagnosis by piezo-transducers". *Earthquake engineering & structural dynamics*, vol. 32, no. 12, pp.1897-1916, Oct. 2003.
4. Bhalla, S. and Soh, C.K., 2004. Structural health monitoring by piezo-impedance transducers. II: applications. *Journal of Aerospace Engineering*, vol. 17, no. 4, pp.166-175, Oct. 2004.
5. D. Luo, Y. Li, J. Li, K.S. Lim, N.A.M. Nazal, H. Ahmad, "A recent progress of steel bar corrosion diagnostic techniques in RC structures". *Sensors*, vol. 19, no. 1, pp.34, Jan. 2019.
6. W. Li, T. Liu, S. Gao, M. Luo, J. Wang and J. Wu, "An electromechanical impedance-instrumented corrosion-measuring probe". *Journal of Intelligent Material Systems and Structures*, vol. 30, no. 14, pp.2135-2146, Aug. 2019.
7. V. Talakokula, S. Bhalla, B. Bhattacharjee and A. Gupta, "Non-destructive assessment of rebar corrosion using piezo-transducers using equivalent structural parameters". *Current Science*, pp.9-38, March 2015.
8. C. Liang, F.P. Sun and C.A. Rogers, "Coupled electro-mechanical analysis of adaptive material systems-determination of the actuator power consumption and system energy transfer". *Journal of intelligent material systems and structures*, vol. 8, no. 4, pp.335-343, Apr. 1997.

9. W.S. Na and J. Baek, "A review of the piezoelectric electromechanical impedance based structural health monitoring technique for engineering structures". *Sensors*, vol. 18, no. 5, pp.1-18, May 2018.
10. V. Talakokula et al, "Diagnosis of carbonation induced corrosion initiation and progression in reinforced concrete structures using piezo-impedance transducers". *Sensors and Actuators A: Physical*, vol. 242, pp.79-91, May 2016.
11. M.T. Visalakshi and S. Bhalla, "Experimental study to detect corrosion in RC structures using piezo-ceramic sensors". *Proceedings of International Conference on Innovations in Concrete Construction, NIT Jalandhar, March 2013*, pp.1454-1461.
12. T. Visalakshi and S. Bhalla, "Reinforcement corrosion assessment capability of surface bonded and embedded piezo sensors for RC structures". *Journal of Intelligent Material System and Structures*, vol. 26, pp.2304-2313, Sep. 2015.
13. D.M. Pearis, G. Park and D.J. Inman "Improving accessibility of the impedance-based structural health monitoring method". *Journal of Intelligent Material Systems and Structures*, vol. 15, no. 2, pp.129-139, Feb. 2004.
14. D. Budoya et al, "Analysis of Piezoelectric Diaphragms in Impedance-Based Damage Detection in Large Structures". In *Multidisciplinary Digital Publishing Institute Proceedings*, vol. 2, no. 3, pp. 1-6, Nov. 2017.
15. J.W. Yang, H.P. Zhu, J. Yu and D.S. Wang, "Experimental study on monitoring steel beam local corrosion based on EMI technique". In *Applied Mechanics and Materials*, vol. 273, pp. 623-627, Jan. 2013.
16. T. Visalakshi et al, "Recent advances in structural health monitoring based on EMI technique". *Trends and Challenges in Concrete Structure*, vol. 19, no. 21, pp.1-10, Dec. 2013.
17. S. Muralidharan, V. Saraswathy, K. Thangavel and S. Srinivasan, "Competitive role of inhibitive and aggressive ions in the corrosion of steel in concrete". *Journal of applied electrochemistry*, vol. 30, no. 11, pp.1255-1259, Nov. 2000.
18. T.H. Ha et al, "Role of sensors in corrosion monitoring and durability assessment in concrete structures: the state of the art". *Sensors and Materials*, vol. 16, no. 3, pp.133-158, Jan. 2004.
19. C. Andrade and C. Alonso, "Corrosion rate monitoring in the laboratory and on-site". *Construction and Building Materials*, vol. 10, no. 5, pp.315-328, Jul. 1996.
20. V. Talakokula, S. Bhalla and A. Gupta, "Corrosion assessment of reinforced concrete structures based on equivalent structural parameters using electro-mechanical impedance technique". *Journal of intelligent material systems and structures*, vol. 25, no.4, pp.484-500, March 2014.
21. M. Raupach, "Half-cell potential measurements—Potential mapping on reinforced concrete structures". *Materials and Structures*, vol. 36, pp.461-471, Aug. 2003.
22. Devesh P. Kansara, Akshay P. Sorathiya and Himanshukumar R. Patel, "Corrosion Monitoring and Detection Techniques in Petrochemical Refineries". *Journal of Electrical and Electronics Engineering*, vol. 13, no.2, pp. 83-93, April 2018.
23. S. Park, B.L. Grisso, D. J. Inman and C.B. Yun, "MFC-based structural health monitoring using a miniaturized impedance measuring chip for corrosion detection". *Research in Nondestructive Evaluation*, vol. 18, no. 2, pp.139-150, April 2007.
24. Jr. Simmers, G.E., "Impedance-based structural health monitoring to detect corrosion (Doctoral dissertation, Virginia Tech)", May 2005.
25. D.T. Thomas, J.T. Welter and V. Giurgiutiu, "Corrosion damage detection with piezoelectric wafer active sensors". In *Health Monitoring and Smart Nondestructive Evaluation of Structural and Biological Systems III International Society for Optics and Photonics*, vol. 5394, pp. 11-22, July 2004.
26. F. Lalande, C.A. Rogers, B.W. Childs and Z.A. Chaudhry, "High-frequency impedance analysis for NDE of complex precision parts. In *Smart Structures and Materials: Smart Structures and Integrated Systems. International Society for Optics and Photonics*, vol. 2717, pp. 237-243, May 1996.
27. S. Bhalla, Y.W. Yang, J. Zhao and C.K. Soh, "Structural Health Monitoring of Underground Facilities—Technological Issues and Challenges",

- Tunnelling and Underground Space Technology, vol. 20, no. 5, 487-500, Sep. 2005.
28. J. Min, S. Park, C.B. Yun, C.G. Lee and C. Lee, "Impedance-based structural health monitoring incorporating neural network technique for identification of damage type and severity". Engineering Structures, vol. 39, pp.210-220, June 2012.
29. Jr. Simmers, G.E., H.A Sodano, G. Park and D.J. Inman, "Impedance based corrosion detection. In Nondestructive Evaluation and Health Monitoring of Aerospace Materials". Composites, and Civil Infrastructure IV. International Society for Optics and Photonics, vol. 5676, pp. 328-339, May 2005.